

# Cage assembly

Model #CP3624

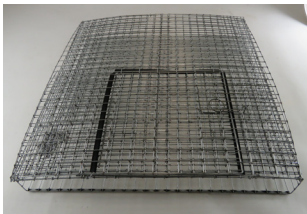

## Pieces



Disassembled cage



Pan



Feeder #MAV



Drinker #605PB  
(Model #605P shown)



Nesting box #55S1R



Clip bag

## Installation

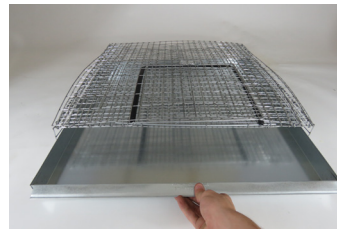

1. Remove the pan from the cage

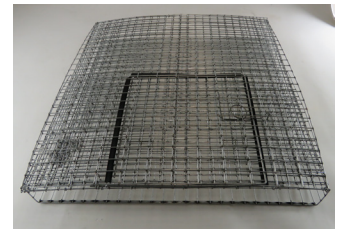

2. Remove the few clips that hold all the pieces using pointed pliers or cutting pliers.

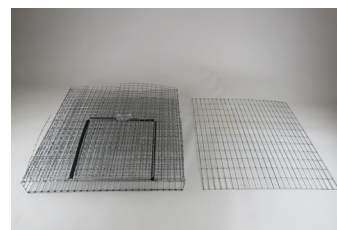

3. Remove the first piece, which will serve as a roof for the cage.



4. Remove the clip that holds the front of the cage

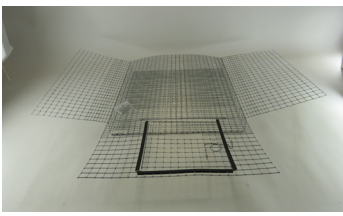

5. Open the front and both sides so that they are on the outside.

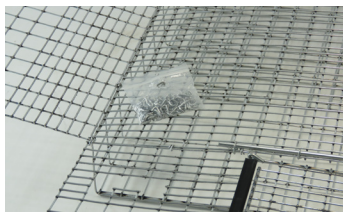

6. Remove the clip that holds the bag containing the staples needed to mount the cage.



7. Lift up the front and one of the sides and install the staples using round staple pliers, such as models #HP or #601.

Note: Installing the top staple first will help hold the sides in place

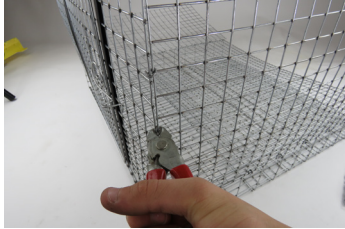

8. Attach the side properly by installing a staple every three inches (7.5 cm).



9. Lift up the other side and install all staples.

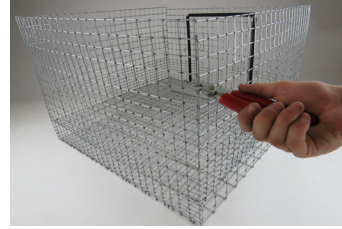

10. Raise the back and install staples on both sides.



11. For models with legs, repeat steps 1 to 10 for each of your cages. For other models, go to step 13.



12. Refer to the document for the leg installation (included with the cage) in order to properly install the legs.

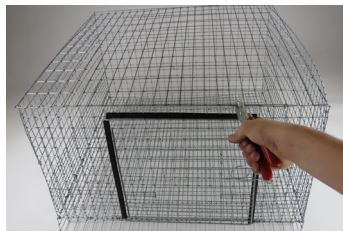

13. Install the roof by attaching staples on all sides.

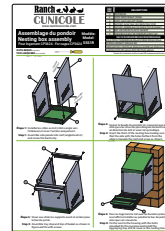

14. Refer to the assembly instruction of the nesting box (included with the cage) to install correctly the nesting box.



15. Attach the feeder on the front of the cage.

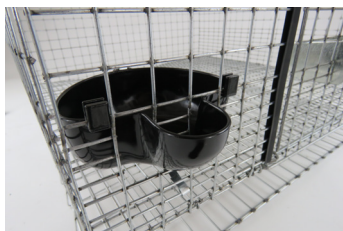

16. Hang the feeder on the front of the cage.



17. Put the drawer back in the cage.

Phone: (450) 799-5170  
info@ranchcunicole.com  
www.ranchcunicole.com

**Ranch**   
**CUNICOLE**



All our cages are made in Canada

6685 Chemin du Rapide Plat Nord  
Saint-Hyacinthe, CA J2R 1H5

## Assemblage du pondoir Nesting box assembly

Modèle: 55S1R  
Model: 55S1R

Pour logement CP3624 · For cages CP3624

**OUTIL REQUIS** (non inclus)  
**TOOL REQUIRED** (not included)



RÉF REF	DESCRIPTION	QTÉ QTY
1	TOIT/ROOF	x1
2	COTÉ DROIT/RIGHT PANEL	x1
3	COTÉ GAUCHE/LEFT PANEL	x1
4	SUPPORT AVANT BAC DE PONTE/TRAY STOP	x1
5	SUPPORT ARRIÈRE BAC DE PONTE/TOP OF BASKET	x1
6	BAC DE PONTE/PLASTIC BASKET	x1
7	COUVERCLE BAC DE PONTE/PLASTIC LID	x1
SAC D'ACCESSOIRES/ACCESSORIES BAG		
	VIS À TÊTE CYLINDRIQUE M5x8/SCREW DIN 84 M5x8	x8
	ÉCROUS M5/NUT DIN 934 M5	x8
	CROCHET EN L FILETÉ ø4,4X46mm/HOOK ø4,4X46mm	x2
	CHEVILLE NYLON ø8mm/NYLON PLUG ø8mm	x2

Toutes les mesures sont en mm/All measurements are in mm

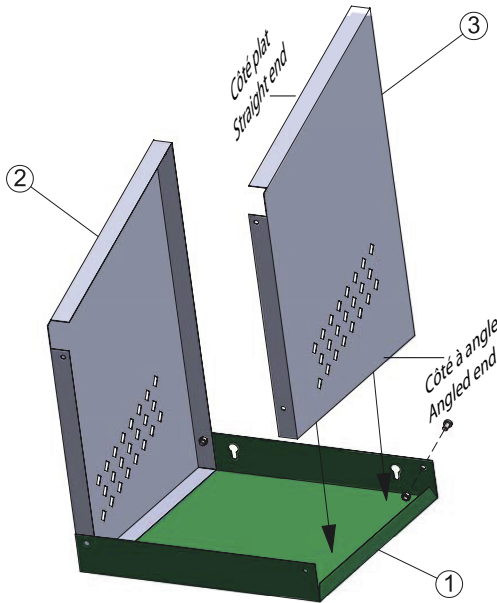

**Étape 1:** Installer les côtés au toit (côté à angle vers l'intérieur) et visser l'arrière uniquement.

**Step 1:** Assemble side panels into roof (angled end in) and screw the back only.

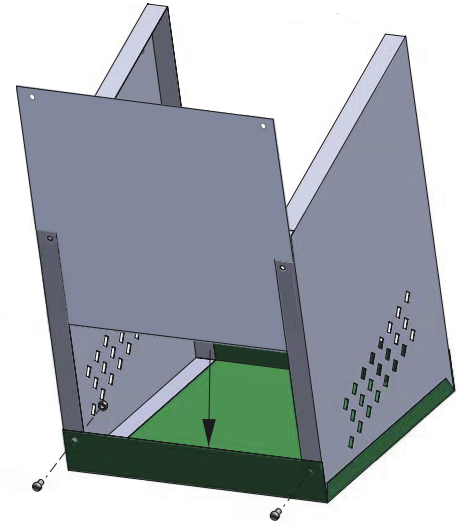

**Étape 2:** Insérer la façade du pondoir en s'assurant que le côté qui a les trous les plus éloignés du bord soit en direction du toit et visser tel qu'indiqué.

**Step 2:** Insert the front of the nesting box making sure that the side with the holes farthest from the edge is towards the roof and screw as shown.

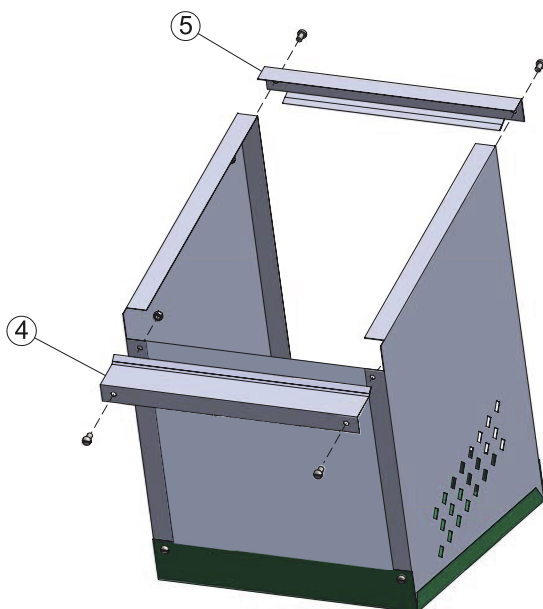

**Étape 3:** Visser aux côtés les supports avant et arrière pour le bac de ponte.

**Step 3:** Assemble tray stop and top of basket as shown in figure and fix with screws.

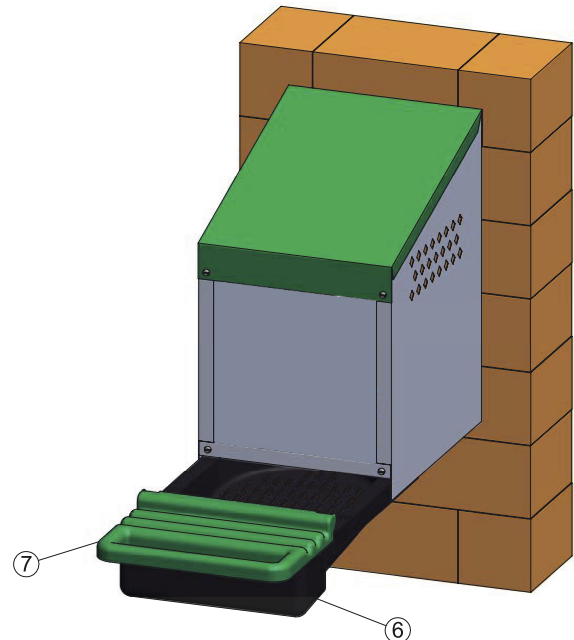

**Étape 4:** Fixer au logement le nid avec les boulons prévus à cet effet et installer au pondoir le bac de ponte ainsi que son couvercle.

**Step 4:** Fix the nest to the housing with the bolts provided for this purpose and install the egg-laying tray and its cover in the nesting box.